



Product description	
BALS-Prd.-Nr	896236
EAN	4024941977166
product group	null
Specification/Norm	null
protection degree	IP44
Colour of appliance	null, Housing top grey
Height	260mm
Width	230mm
Depth	145mm
RDF factor	0.87

Product description

Nominal current InA

16

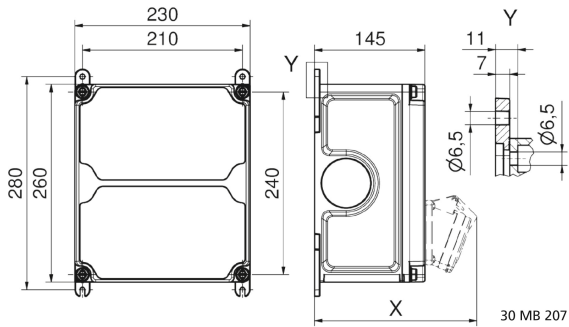

Tiefenmaß/ depth X (mm)

Bezeichnung/ with	IP44	IP67
OTC-Klappe/ OTC operating window	180	180
Schutzk. Steckdose/domestic socket	162	205
CEE 16A 3p	200	200
CEE 16A 4p	204	202
CEE 16A 5p	207	205
CEE 32A 3p/4p	211	213
CEE 32A 5p	213	214
CEE 63A 3p/4p/5p	229	231