

Distributor, rubber, wallmounted

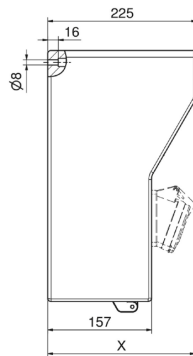

Product description	
BALS-Prd.-Nr	5402053
EAN	4024941948722
product group	null
protection degree	IP44
Colour of appliance	null, null
Height	380mm
Width	370mm
Depth	225mm

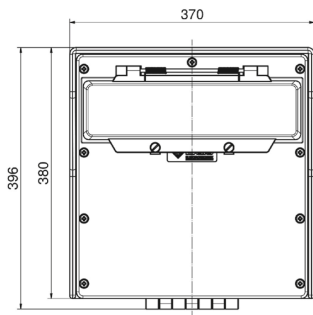

13 MB 117

Tiefenmaß/ depth X (mm)

Bezeichnung/ with	IP44	IP67
Schutzk. Steckdose/domestic socket	172	215
CEE 16A 3p	210	210
CEE 16A 4p	214	212
CEE 16A 5p	217	215
CEE 32A 3p/4p	221	223
CEE 32A 5p	223	224
CEE 63A 3p/4p/5p	239	241