

## Distributor, rubber, wallmounted

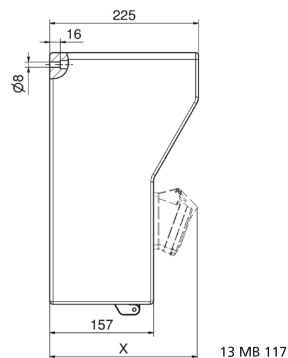

Product description	
BALS-Prd.-Nr	5402051
EAN	4024941948708
product group	null
protection degree	IP44
Colour of appliance	null, null
Height	380mm
Width	370mm
Depth	225mm

Logistics data	
Weight/pcs	0.0 kg / Piece
Packaging	Carton
Content amount	1 ST
EAN	4024941948708
Length	590 mm
Width	380 mm
Height	230 mm
Weight	0.755 kg
Volume	45,066 ccm

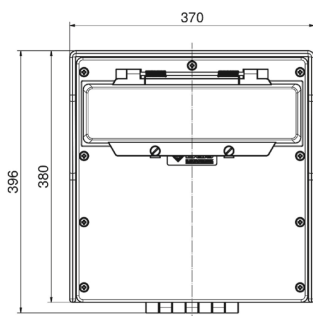

Tiefenmaß/ depth X (mm)

Bezeichnung/ with	IP44	IP67
Schutzk. Steckdose/domestic socket	172	215
CEE 16A 3p	210	210
CEE 16A 4p	214	212
CEE 16A 5p	217	215
CEE 32A 3p/4p	221	223
CEE 32A 5p	223	224
CEE 63A 3p/4p/5p	239	241