

wall mounting appliance inlet - housing dimensions 80x70



Product description	
BALS-Prd.-Nr	466
EAN	4024941004664
product category (PG)	ELV wall mounting appliance inlet
current (A)	16A
number of poles (P99)	3p
number of poles (P)	3P
position of earth contact (H)	no minor keyway
voltage (V)	20 up to 25v
frequency (HZ)	50 and 60Hz

Product description	
protection degree (SA)	IP44
colour code 1 (KF1)	violet RAL 4005
Colour of appliance	Collar violet, Housing bottom grey, Housing top grey
connection design (AT)	screw terminal
maximum conductor size (LQ)	10,0 qmm
cable entry (KE)	top entry M25
Height	102mm
Width	70mm
Depth	63mm
dimension of enclosure (GG)	80x70 mm (HxW)
material of enclosure (GM)	Polyamide
contact	The contact carrier is made of polyamide, The contacts are brass

Additional technical information	
	The cable entry is one at top open

Logistics data	
Weight/pcs	0.149 kg / Piece
Packaging	Carton
Content amount	10 ST
EAN	4024941837231

Logistics data	
Length	245 mm
Width	177 mm
Height	185 mm
Weight	1.623 kg
Volume	7,140 ccm

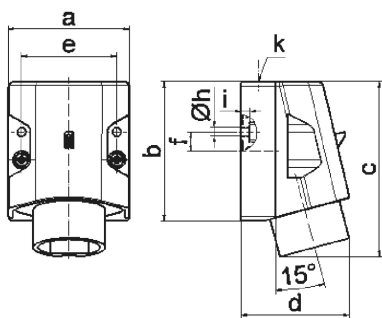

16 MB 15

Ampere	16	16	32	32		
Polzahl	2	3	2	3		
a	70,0	70,0	70,0	70,0		
b	80,0	80,0	80,0	80,0		
c	100,0	100,0	100,0	100,0		
d	82,0	82,0	82,0	82,0		
e	55,0	55,0	55,0	55,0		
f	11,0	11,0	11,0	11,0		
h ø	5,2	5,2	5,2	5,2		
i	5,0	5,0	5,0	5,0		
k	M25	M25	M25	M25		
Leiter mm ² min	4	4	4	4		
Leiter mm ² max	10	10	10	10		