

Plug - with cable gland, Multi-Grip



Product description	
BALS-Prd.-Nr	4433
EAN	4024941044332
product group	ELV plug
current	32A
number of poles	2p
Arrangement of the phases	2P
position of earth contact	no minor keyway
voltage (V)	20 up to 25v
frequency	50 and 60Hz

Product description	
protection degree	IP44
colour code	violet RAL 4005
Colour of appliance	Housing cover grey, Cable gland grey, Collar violet
connection design	screw terminal
maximum conductor size (LQ)	10,0 qmm
cable entry (KE)	Cable gland
Height	141mm
Width	62mm
Depth	57mm
material of enclosure	Polyamide
contact	The contact carrier is made of polyamide, the contacts are brass nickel plated

Additional technical information	
	Multi-Grip cable gland with gasket and integrated strain relief, For cable diameter from 11 up to max. 23,5 mm

Logistics data	
Weight/pcs	0.125 kg / Piece
Packaging	Bag
Content amount	1 ST
EAN	4024941044332
Length	57 mm

Logistics data	
Width	62 mm
Height	141 mm
Weight	0.126 kg
Volume	498.294 ccm
Packaging	Carton
Content amount	10 ST
EAN	4024941819466
Length	248 mm
Width	158 mm
Height	123 mm
Weight	1.347 kg
Volume	3,960 ccm

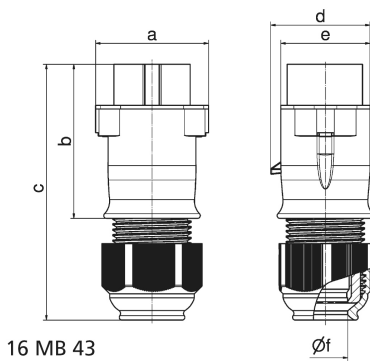

Ampere	16	16	32	32			
Polzahl	2	3	2	3			
a	62,0	62,0	62,0	62,0			
b	85,0	85,0	85,0	85,0			
c	140,0	140,0	140,0	140,0			
d	55,0	55,0	55,0	55,0			
e	50,0	50,0	50,0	50,0			
f Ø	24,5	24,5	24,5	24,5			
Leiter mm ² min	4	4	4	4			
Leiter mm ² max	10	10	10	10			