

panel mounting socket outlet - straight execution, flange 55x55, fixing centers 45x45



Product description	
BALS-Prd.-Nr	4318
EAN	4024941043182
product category (PG)	ELV panel mounting socket outlet, straight
current (A)	32A
number of poles (P99)	3p
number of poles (P)	3P
position of earth contact (H)	12 h
voltage (V)	40 up to 50V

Product description	
frequency (HZ)	50 and 60Hz
protection degree (SA)	IP44
colour code 1 (KF1)	gray RAL 7035
Colour of appliance	Hinged lid grey, Enclosure grey
connection design (AT)	screw terminal
maximum conductor size (LQ)	10,0 qmm
cable entry (KE)	null
Height	67mm
Width	55mm
Depth	59mm
Flange size vertical	55mm
Flange size horizontal	55mm
Drill hole distance vertical	45mm
Drill hole distance horizontal	45mm
material of enclosure (GM)	Polyamide
contact	The contact carrier is made of polyamide, the contacts are brass nickel plated

Logistics data	
Weight/pcs	0.126 kg / Piece
Packaging	Bag
Content amount	1 ST

Logistics data	
EAN	4024941043182
Length	59 mm
Width	55 mm
Height	67 mm
Weight	0.127 kg
Volume	217.415 ccm
Packaging	Carton
Content amount	10 ST
EAN	4024941836548
Length	207 mm
Width	162 mm
Height	142 mm
Weight	1.36 kg
Volume	3,750 ccm

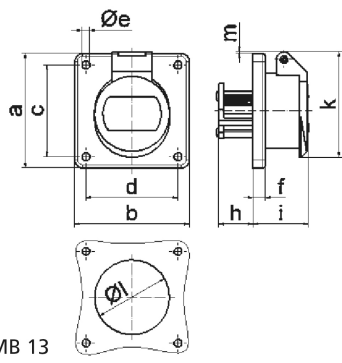

16 MB 13

Ampere	16	16	32	32		
Polzahl	2	3	2	3		
a	55,0	55,0	55,0	55,0		
b	55,0	55,0	55,0	55,0		
c	45,0	45,0	45,0	45,0		
d	45,0	45,0	45,0	45,0		
e ø	5,2	5,2	5,2	5,2		
f	6,0	6,0	6,0	6,0		
h	22,0	22,0	22,0	22,0		
i	37,0	37,0	37,0	37,0		
k	67,0	67,0	67,0	67,0		
l ø	49,0	49,0	49,0	49,0		
m	12,0	12,0	12,0	12,0		
Leiter mm ² min	4	4	4	4		
Leiter mm ² max	10	10	10	10		