

panel mounting socket outlet - angled execution, flange 68x62, fixing centers 53x47



Product description	
BALS-Prd.-Nr	429
EAN	4024941004299
product category	ELV panel mounting socket Outlet, angled
current	16A
number of poles	3p
number of poles	3P
position of earth contact	2 h
voltage	20 up to 25 and 40 up to 50V

Product description	
frequency	300Hz
protection degree	IP44
colour code	green RAL 6002
Colour of appliance	Hinged lid green, Enclosure grey
connection design	screw terminal
maximum conductor size	10,0 qmm
cable entry	null
Height	69mm
Width	62mm
Depth	70mm
Flange size vertical	68mm
Flange size horizontal	62mm
Drill hole distance vertical	53mm
Drill hole distance horizontal	47mm
material of enclosure	Polyamide
contact	The contact carrier is made of polyamide, the contacts are brass nickel plated

Additional technical information	
	The inclination is 20°

Logistics data	
Weight/pcs	0.155 kg / Piece
Packaging	Carton
Content amount	10 ST
EAN	4024941836944
Length	207 mm
Width	162 mm
Height	142 mm
Weight	1.65 kg
Volume	3,750 ccm

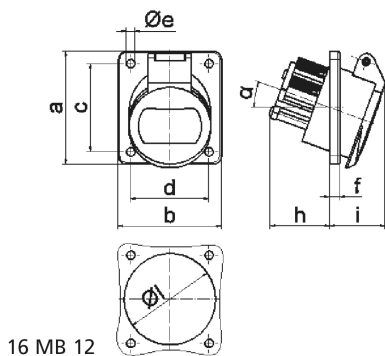

Ampere	16	16	32	32		
Polzahl	2	3	2	3		
a	68,0	68,0	68,0	68,0		
b	62,0	62,0	62,0	62,0		
c	53,0	53,0	53,0	53,0		
d	47,0	47,0	47,0	47,0		
e ø	5,2	5,2	5,2	5,2		
f	6,0	6,0	6,0	6,0		
h	36,0	36,0	36,0	36,0		
i	35,0	35,0	35,0	35,0		
α	20°	20°	20°	20°		
l ø	55,0	55,0	55,0	55,0		
Leiter mm ² min	4	4	4	4		
Leiter mm ² max	10	10	10	10		