

wall mounting socket outlet - housing dimensions 80x70



Product description	
BALS-Prd.-Nr	4111
EAN	4024941041119
product category (PG)	ELV wall mounting socket outlet
current (A)	32A
number of poles (P99)	2p
number of poles (P)	2P
position of earth contact (H)	no minor keyway
voltage (V)	20 up to 25v
frequency (HZ)	50 and 60Hz

Product description	
protection degree (SA)	IP44
colour code 1 (KF1)	violet RAL 4005
Colour of appliance	Housing bottom grey, Housing top grey, Hinged lid violet, Collar grey
connection design (AT)	screw terminal
maximum conductor size (LQ)	10,0 qmm
cable entry (KE)	top entry M25
Height	113mm
Width	70mm
Depth	79mm
dimension of enclosure (GG)	80x70 mm (HxW)
material of enclosure (GM)	Polyamide
contact	The contact carrier is made of polyamide, the contacts are brass nickel plated

Additional technical information	
	The cable entry is one at top open

Logistics data	
Weight/pcs	0.176 kg / Piece
Packaging	Bag
Content amount	1 ST
EAN	4024941041119

Logistics data	
Length	79 mm
Width	70 mm
Height	113 mm
Weight	0.177 kg
Volume	624.89 ccm
Packaging	Carton
Content amount	10 ST
EAN	4024941968102
Length	245 mm
Width	177 mm
Height	185 mm
Weight	1.893 kg
Volume	7,140 ccm

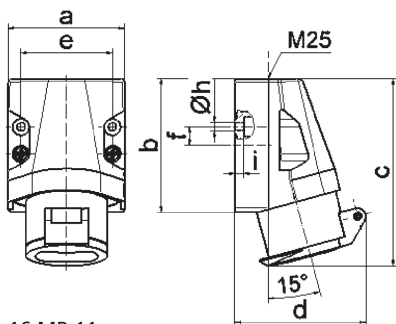

16 MB 11

Ampere	16	16	32	32		
Polzahl	2	3	2	3		
a	70,0	70,0	70,0	70,0		
b	80,0	80,0	80,0	80,0		
c	113,0	113,0	113,0	113,0		
d	80,0	80,0	80,0	80,0		
e	55,0	55,0	55,0	55,0		
f	11,0	11,0	11,0	11,0		
h ø	5,2	5,2	5,2	5,2		
i	5,0	5,0	5,0	5,0		
Leiter mm ² min	4	4	4	4		
Leiter mm ² max	10	10	10	10		