

wall mounting socket outlet - housing dimensions 80x70



Product description	
BALS-Prd.-Nr	4110
EAN	4024941041102
product category	ELV wall mounting socket outlet
current	16A
number of poles	3p
number of poles	3P
position of earth contact	3 h
voltage	20 up to 25 and 40 up to 50V
frequency	400Hz

Product description	
protection degree	IP44
colour code	green RAL 6002
Colour of appliance	Hinged lid green, Housing bottom grey, Housing top grey, Collar grey
connection design	screw terminal
maximum conductor size	10,0 qmm
cable entry	top entry M25
Height	113mm
Width	70mm
Depth	79mm
dimension of enclosure	80x70 mm (HxW)
material of enclosure	Polyamide
contact	The contact carrier is made of polyamide, the contacts are brass nickel plated

Additional technical information	
	The cable entry is one at top open

Logistics data	
Weight/pcs	0.2 kg / Piece
Packaging	Carton
Content amount	10 ST
EAN	4024941836494

Logistics data	
Length	245 mm
Width	177 mm
Height	185 mm
Weight	2.133 kg
Volume	7,140 ccm

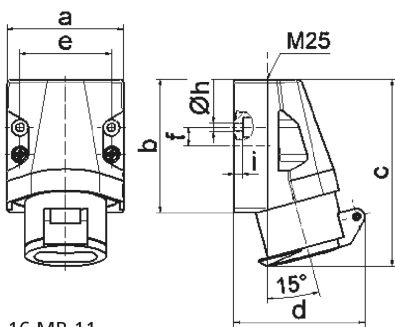

Ampere	16	16	32	32			
Polzahl	2	3	2	3			
a	70,0	70,0	70,0	70,0			
b	80,0	80,0	80,0	80,0			
c	113,0	113,0	113,0	113,0			
d	80,0	80,0	80,0	80,0			
e	55,0	55,0	55,0	55,0			
f	11,0	11,0	11,0	11,0			
h ø	5,2	5,2	5,2	5,2			
i	5,0	5,0	5,0	5,0			
Leiter mm ² min	4	4	4	4			
Leiter mm ² max	10	10	10	10			