

connector - with screw terminals one piece housing



Product description	
BALS-Prd.-Nr	31210-TLS
EAN	4024941199599
product category	TLS connector Multi-Grip cable gland
current	16A
number of poles	3p
number of poles	2P+PE
position of earth contact	7 h
voltage	480 up to 500V
frequency	50 and 60Hz

Product description	
protection degree	IP44
colour code	black RAL 9005
Colour of appliance	Enclosure black, Hinged lid black, Cable gland grey
connection design	screw terminal
maximum conductor size	2,5 qmm
cable entry	Cable gland
Height	149mm
Width	52mm
Depth	74mm
material of enclosure	Polyamide
contact	The contact carrier is made of polyamide, The contacts are brass

Additional technical information	
	one piece housing, Multi-Grip cable gland with gasket and integrated strain relief, For cable diameter from 8 up to max. 18 mm

Logistics data	
Weight/pcs	0.16 kg / Piece
Packaging	Bag
Content amount	1 ST
EAN	4024941199599
Length	74 mm

Logistics data	
Width	52 mm
Height	149 mm
Weight	0.161 kg
Volume	573.352 ccm
Packaging	Carton
Content amount	10 ST
EAN	4024941841740
Length	275 mm
Width	175 mm
Height	137 mm
Weight	1.725 kg
Volume	5,737.5 ccm

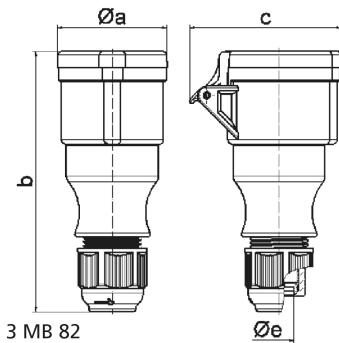

Ampere	16	16	16	32	32	32
Polzahl	3	4	5	3	4	5
a ø	51,0	58,0	65,0	67,0	67,0	73,0
b	145,0	148,0	156,0	185,0	185,0	185,0
c	74,0	84,0	90,0	94,0	94,0	102,0
e ø	18,0	18,0	18,0	23,0	23,0	23,0
Leiter mm ² min	1	1	1	2,5	2,5	2,5
Leiter mm ² max	2,5	2,5	2,5	6	6	6