

phase inverter, as panel mounting socket inlet flange,
straight - flange 85x85, fixing centers 70x70



Product description	
BALS-Prd.-Nr	28181
EAN	4024941281812
Product category	TE phase inverter as panel mounting appliance inlet straight
Current	16A
Number of poles	5p
Number of poles	3p+N+PE
Position of earth contact	6 h
Voltage	200/346 up to 240/415V

Product description	
Frequency	50 and 60Hz
Protection degree	IP44
Colour code	red RAL 3000
Colour of appliance	Collar red RAL 3000, Enclosure grey RAL 7035
Connection design	with screw terminal
Maximum conductor size	2,5 qmm
Cable entry	null
Height	85mm
Width	85mm
Depth	77mm
Flange size vertical	85mm
Flange size horizontal	85mm
Drill hole distance vertical	70mm
Drill hole distance horizontal	70mm
Material of enclosure	Polyamide
Contact	The contact carrier is made of high temperature resistant material, the contacts are brass nickel plated

Additional technical information	
	A retaining device to match the hinged cover of the connector must be provided to ensure the latching feature

Logistics data	
Weight/pcs	0.195 kg / Piece
Packaging	Bag
Content amount	1 ST
EAN	4024941281812
Length	77 mm
Width	85 mm
Height	85 mm
Weight	0.196 kg
Volume	556.325 ccm
Packaging	Carton
Content amount	10 ST
EAN	4024941826372
Length	245 mm
Width	177 mm
Height	185 mm
Weight	2.083 kg
Volume	7,140 ccm

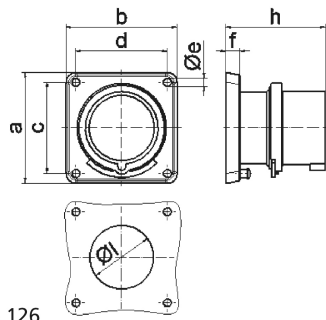

5 MB 126

Ampere	16	16	16	32	32	32
Polzahl	3	4	5	3	4	5
a	85,0	85,0	85,0	85,0	85,0	85,0
b	85,0	85,0	85,0	85,0	85,0	85,0
c	70,0	70,0	70,0	70,0	70,0	70,0
d	70,0	70,0	70,0	70,0	70,0	70,0
e ø	6,3	6,3	6,3	6,3	6,3	6,3
f	11,0	11,0	11,0	11,0	11,0	11,0
h	75,5	75,0	76,5	85,0	85,0	85,0
l ø	49,0	49,0	49,0	49,0	49,0	49,0
Leiter mm ² min	1	1	1	2,5	2,5	2,5
Leiter mm ² max	2,5	2,5	2,5	6	6	6