

panel mounting appliance inlet, straight - flange 85x85,
fixing centers 70x70



Product description	
BALS-Prd.-Nr	28108
EAN	4024941281089
product category (PG)	GT panel mounting appliance inlet, straight
current (A)	32A
number of poles (P99)	5p
number of poles (P)	3p+N+PE
position of earth contact (H)	6 h
voltage (V)	200/346 up to 240/415V

Product description	
frequency (HZ)	50 and 60Hz
protection degree (SA)	IP44
colour code 1 (KF1)	red RAL 3000
Colour of appliance	Collar red, Enclosure grey
connection design (AT)	screw terminal
maximum conductor size (LQ)	6,0 qmm
cable entry (KE)	null
Height	88mm
Width	85mm
Depth	86mm
Flange size vertical	85mm
Flange size horizontal	85mm
Drill hole distance vertical	70mm
Drill hole distance horizontal	70mm
material of enclosure (GM)	Polyamide
contact	The contact carrier is made of polyamide, The contacts are brass

Additional technical information	
	A retaining device to match the hinged cover of the connector must be provided to ensure the latching feature

Logistics data	
Weight/pcs	0.24 kg / Piece
Packaging	Bag
Content amount	1 ST
EAN	4024941281089
Length	86 mm
Width	85 mm
Height	88 mm
Weight	0.241 kg
Volume	643.28 ccm
Packaging	Carton
Content amount	10 ST
EAN	4024941940498
Length	258 mm
Width	183 mm
Height	212 mm
Weight	2.552 kg
Volume	8,750 ccm

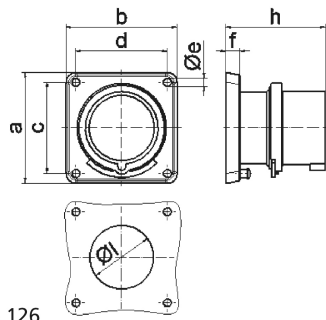

5 MB 126

Ampere	16	16	16	32	32	32
Polzahl	3	4	5	3	4	5
a	85,0	85,0	85,0	85,0	85,0	85,0
b	85,0	85,0	85,0	85,0	85,0	85,0
c	70,0	70,0	70,0	70,0	70,0	70,0
d	70,0	70,0	70,0	70,0	70,0	70,0
e ø	6,3	6,3	6,3	6,3	6,3	6,3
f	11,0	11,0	11,0	11,0	11,0	11,0
h	75,5	75,0	76,5	85,0	85,0	85,0
l ø	49,0	49,0	49,0	49,0	49,0	49,0
Leiter mm ² min	1	1	1	2,5	2,5	2,5
Leiter mm ² max	2,5	2,5	2,5	6	6	6