

panel mounting appliance inlet - without closure cap



Product description	
BALS-Prd.-Nr	2694
EAN	4024941026949
product category (PG)	GT surface mounting appliance inlet
current (A)	32A
number of poles (P99)	4p
number of poles (P)	3P+PE
position of earth contact (H)	9 h
voltage (V)	200 up to 250V
frequency (HZ)	50 and 60Hz

Product description	
protection degree (SA)	IP67
colour code 1 (KF1)	blue RAL 5015
Colour of appliance	Collar blue, Bayonet ring grey, Enclosure grey
connection design (AT)	screw terminal
maximum conductor size (LQ)	6,0 qmm
cable entry (KE)	null
Height	137mm
Width	94mm
Depth	98mm
Flange size vertical	75mm
Flange size horizontal	90mm
Drill hole distance vertical	45mm
Drill hole distance horizontal	78mm
material of enclosure (GM)	Polyamide
contact	The contact carrier is made of polyamide, the contacts are brass nickel plated

Logistics data	
Weight/pcs	0.265 kg / Piece
Packaging	Bag
Content amount	1 ST
EAN	4024941026949

Logistics data	
Length	98 mm
Width	94 mm
Height	137 mm
Weight	0.266 kg
Volume	1,262.044 ccm
Packaging	Carton
Content amount	10 ST
EAN	4024941833394
Length	325 mm
Width	217 mm
Height	210 mm
Weight	2.856 kg
Volume	13,588.4 ccm

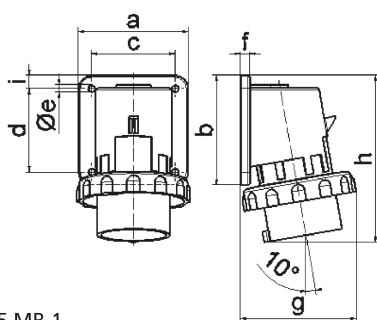

5 MB 1

Ampere	16	16	16	32	32	32
Polzahl	3	4	5	3	4	5
a	74,0	75,0	84,0	90,0	90,0	90,0
b	84,0	100,0	84,0	75,0	75,0	75,0
c	58,0	62,0	64,0	78,0	78,0	78,0
d	64,0	74,0	64,0	45,0	45,0	45,0
e ø	5,5	4,3	5,5	5,5	5,5	5,5
f	12,0	12,0	7,0	7,0	7,0	7,0
g	80,0	88,0	90,0	100,0	100,0	101,0
h	128,0	145,0	129,0	138,0	138,0	139,0
i	-	-	10,0	13,0	13,0	13,0
Leiter mm² min	1	1	1	2,5	2,5	2,5
Leiter mm² max	2,5	2,5	2,5	6	6	6