

panel mounting appliance inlet - with hinged cover



Product description	
BALS-Prd.-Nr	2656
EAN	4024941026567
product category (PG)	GT surface mounting appliance inlet
current (A)	32A
number of poles (P99)	3p
number of poles (P)	2P+PE
position of earth contact (H)	6 h
voltage (V)	200 up to 250V
frequency (HZ)	50 and 60Hz

Product description	
protection degree (SA)	IP44
colour code 1 (KF1)	blue RAL 5015
Colour of appliance	Hinged lid grey, Collar blue, Enclosure grey
connection design (AT)	screw terminal
maximum conductor size (LQ)	6,0 qmm
cable entry (KE)	null
Height	148mm
Width	90mm
Depth	116mm
Flange size vertical	75mm
Flange size horizontal	90mm
Drill hole distance vertical	45mm
Drill hole distance horizontal	78mm
material of enclosure (GM)	Polyamide
contact	The contact carrier is made of polyamide, The contacts are brass

Additional technical information	
	With hinged lid

Logistics data	
Weight/pcs	0.299 kg / Piece

Logistics data	
Packaging	Bag
Content amount	1 ST
EAN	4024941026567
Length	116 mm
Width	90 mm
Height	148 mm
Weight	0.3 kg
Volume	1,545.12 ccm
Packaging	Carton
Content amount	10 ST
EAN	4024941833264
Length	325 mm
Width	217 mm
Height	210 mm
Weight	3.196 kg
Volume	13,588.4 ccm

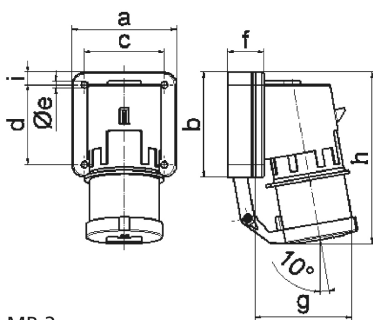

5 MB 2

Ampere Polzahl	16 3	16 4	16 5	32 3	32 4	32 5
a	74,0	75,0	84,0	90,0	90,0	90,0
b	84,0	100,0	84,0	75,0	75,0	75,0
c	58,0	62,0	64,0	78,0	78,0	78,0
d	64,0	74,0	64,0	45,0	45,0	45,0
e ø	5,5	4,3	5,5	5,5	5,5	5,5
f	12,0	12,0	29,0	29,0	29,0	29,0
g	78,0	88,0	105,0	114,0	114,0	115,0
h	134,0	151,0	138,0	149,0	149,0	150,0
i	-	-	-	13,0	13,0	13,0
Leiter mm ² min	1	1	1	2,5	2,5	2,5
Leiter mm ² max	2,5	2,5	2,5	6	6	6