

plug - with TE screw terminals, for harsh applications



Product description	
BALS-Prd.-Nr	2181
EAN	4024941021814
product group	TE plug
current	63A
number of poles	3p
Arrangement of the phases	2P+PE
position of earth contact	6 h
voltage (V)	200 up to 250V
frequency	50 and 60Hz

Product description	
protection degree	IP67
colour code	blue RAL 5015
Colour of appliance	Pusher grey, Collar blue, Bayonet ring grey, Housing cover grey, Cable gland grey
connection design	box terminal
maximum conductor size (LQ)	16,0 qmm
cable entry (KE)	Cable gland
Height	234mm
Width	114mm
Depth	114mm
material of enclosure	Polyamide
contact	The contact carrier is made of high temperature resistant material, the contacts are brass nickel plated

Additional technical information	
	For cable diameter from 16 up to max. 36 mm, Screwless housing connection, Multi-Grip cable gland with gasket, integrated cable clamp and additional water evacuation openings

Logistics data	
Weight/pcs	0.59 kg / Piece
Packaging	Bag
Content amount	1 ST
EAN	4024941021814

Logistics data	
Length	114 mm
Width	114 mm
Height	234 mm
Weight	0.591 kg
Volume	3,041.064 ccm
Packaging	Carton
Content amount	5 ST
EAN	4024941964463
Length	325 mm
Width	217 mm
Height	210 mm
Weight	3.156 kg
Volume	13,588.4 ccm

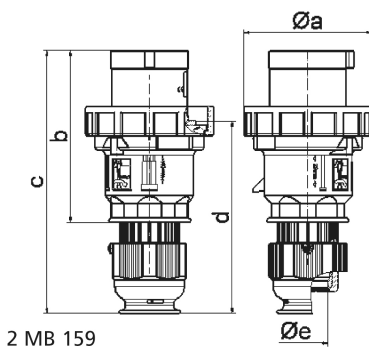

Ampere	63	63	63			
Polzahl	3	4	5			
a ø	113,5	113,5	113,5			
b	153,0	153,0	153,0			
c	233,0	233,0	233,0			
d	171,0	171,0	171,0			
e ø	36,0	36,0	36,0			
Leiter mm² min	6	6	6			
Leiter mm² max	16	16	16			