

plug - with screwless terminals, for harsh applications



Product description	
BALS-Prd.-Nr	21545
EAN	4024941215459
product group	Quick-Connect TE plug
current	32A
number of poles	3p
Arrangement of the phases	2P+PE
position of earth contact	10 h
voltage (V)	> 50V
frequency	100 up to 300Hz

Product description	
protection degree	IP67
colour code	green RAL 6002
Colour of appliance	Bayonet ring grey, Cable gland grey, Housing cover green, Collar green
connection design	screwless spring-clamp
maximum conductor size (LQ)	6,0 qmm
cable entry (KE)	Cable gland
Height	180mm
Width	94mm
Depth	94mm
material of enclosure	Polyamide
contact	The contact carrier is made of high temperature resistant material, the contacts are brass nickel plated

Additional technical information	
	For cable diameter from 11 up to max. 23,5 mm, Multi-Grip cable gland with gasket, integrated cable clamp and additional water evacuation openings

Logistics data	
Weight/pcs	0.29 kg / Piece
Packaging	Carton
Content amount	10 ST
EAN	4024941832007

Logistics data	
Length	325 mm
Width	217 mm
Height	210 mm
Weight	3.106 kg
Volume	13,588.4 ccm

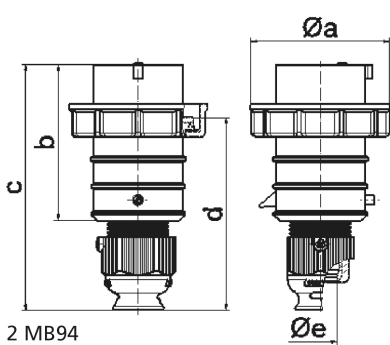

2 MB94

Ampere	16	16	16	32	32	32
Polzahl	3	4	5	3	4	5
a ø	70,0	78,0	86,0	94,0	94,0	101,0
b	95,0	95,0	97,0	118,0	118,0	117,0
c	145,0	145,0	152,0	178,0	178,0	181,0
d	111,0	111,0	119,0	136,0	136,0	138,5
e ø	18,0	18,0	21,0	23,0	23,0	27,0
Leiter mm² min	1	1	1	2,5	2,5	2,5
Leiter mm² max	2,5	2,5	2,5	6	6	6