

plug - with screw terminals one piece housing



Product description	
BALS-Prd.-Nr	21012-TLS
EAN	4024941199193
product category	TLS plug with Multi-Grip cable gland
current	32A
number of poles	3p
number of poles	2P+PE
position of earth contact	4 h
voltage	100 up to 130V
frequency	50 and 60Hz

Product description	
protection degree	IP44
colour code	yellow RAL 1012
Colour of appliance	Enclosure yellow, Cable gland grey
connection design	screw terminal
maximum conductor size	6,0 qmm
cable entry	Cable gland
Height	167mm
Width	71mm
Depth	81mm
material of enclosure	Polyamide
contact	The contact carrier is made of polyamide, The contacts are brass

Additional technical information	
	one piece housing, Multi-Grip cable gland with gasket and integrated strain relief, For cable diameter from 11 up to max. 23,5 mm

Logistics data	
Weight/pcs	0.2 kg / Piece
Packaging	Bag
Content amount	1 ST
EAN	4024941199193
Length	81 mm

Logistics data	
Width	71 mm
Height	167 mm
Weight	0.201 kg
Volume	960.417 ccm
Packaging	Carton
Content amount	10 ST
EAN	4024941826822
Length	245 mm
Width	177 mm
Height	185 mm
Weight	2.133 kg
Volume	7,140 ccm

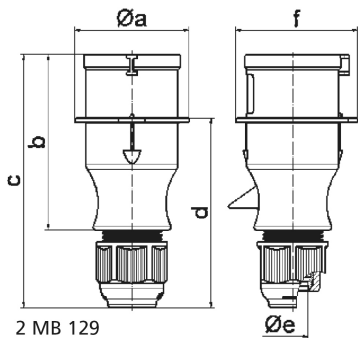

Ampere	16	16	16	32	32	32
Polzahl	3	4	5	3	4	5
a ø	54,0	60,0	66,0	71,0	71,0	80,0
b	94,5	98,0	101,0	115,0	115,0	119,0
c	138,0	142,0	145,0	170,0	170,0	174,0
d	101,5	105,5	108,5	124,0	124,0	128,0
e ø	18,0	18,0	18,0	23,0	23,0	23,0
f	56,6	64,0	71,0	76,0	76,0	85,0
Leiter mm ² min	1	1	1	2,5	2,5	2,5
Leiter mm ² max	2,5	2,5	2,5	6	6	6