

plug - with screw terminals one piece housing



Product description	
BALS-Prd.-Nr	21006-TLS
EAN	4024941193160
product category	TLS plug with Multi-Grip cable gland
current	16A
number of poles	4p
number of poles	3P+PE
position of earth contact	7 h
voltage	480 up to 500V
frequency	50 and 60Hz

Product description	
protection degree	IP44
colour code	black RAL 9005
Colour of appliance	Enclosure black, Cable gland grey
connection design	screw terminal
maximum conductor size	2,5 qmm
cable entry	Cable gland
Height	143mm
Width	60mm
Depth	68mm
material of enclosure	Polyamide
contact	The contact carrier is made of polyamide, The contacts are brass

Additional technical information	
	one piece housing, Multi-Grip cable gland with gasket and integrated strain relief, For cable diameter from 8 up to max. 18 mm

Logistics data	
Weight/pcs	0.13 kg / Piece
Packaging	Bag
Content amount	1 ST
EAN	4024941193160
Length	68 mm

Logistics data	
Width	60 mm
Height	143 mm
Weight	0.131 kg
Volume	583.44 ccm
Packaging	Carton
Content amount	10 ST
EAN	4024941826808
Length	248 mm
Width	158 mm
Height	123 mm
Weight	1.397 kg
Volume	3,960 ccm

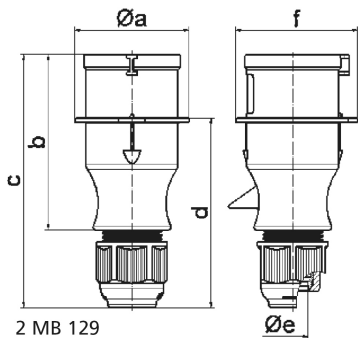

Ampere	16	16	16	32	32	32
Polzahl	3	4	5	3	4	5
a ø	54,0	60,0	66,0	71,0	71,0	80,0
b	94,5	98,0	101,0	115,0	115,0	119,0
c	138,0	142,0	145,0	170,0	170,0	174,0
d	101,5	105,5	108,5	124,0	124,0	128,0
e ø	18,0	18,0	18,0	23,0	23,0	23,0
f	56,6	64,0	71,0	76,0	76,0	85,0
Leiter mm ² min	1	1	1	2,5	2,5	2,5
Leiter mm ² max	2,5	2,5	2,5	6	6	6