

plug - with screw terminals one piece housing



Product description	
BALS-Prd.-Nr	21004-TLS
EAN	4024941199131
product category (PG)	TLS plug with Multi-Grip cable gland
current (A)	16A
number of poles (P99)	4p
number of poles (P)	3P+PE
position of earth contact (H)	9 h
Voltage	200 up to 250V
frequency (HZ)	50 and 60Hz

Product description	
protection degree (SA)	IP44
colour code 1 (KF1)	blue RAL 5015
Colour of appliance	Enclosure blue, Cable gland grey
connection design (AT)	with screw terminal
maximum conductor size (LQ)	2,5 qmm
cable entry (KE)	Cable gland
Height	143mm
Width	60mm
Depth	68mm
material of enclosure (GM)	Polyamide
contact	The contact carrier is made of polyamide, The contacts are brass

Additional technical information	
	one piece housing, Multi-Grip cable gland with gasket and integrated strain relief, For cable diameter from 8 up to max. 18 mm

Logistics data	
Weight/pcs	0.13 kg / Piece
Packaging	Carton
Content amount	10 ST
EAN	4024941828185
Length	248 mm

Logistics data	
Width	158 mm
Height	123 mm
Weight	1.397 kg
Volume	3,960 ccm

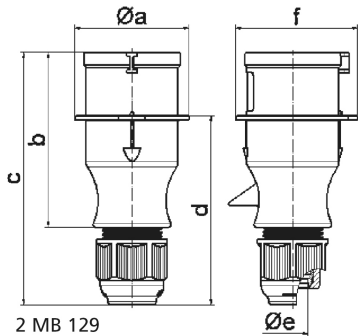

Ampere	16	16	16	32	32	32
Polzahl	3	4	5	3	4	5
a ø	54,0	60,0	66,0	71,0	71,0	80,0
b	94,5	98,0	101,0	115,0	115,0	119,0
c	138,0	142,0	145,0	170,0	170,0	174,0
d	101,5	105,5	108,5	124,0	124,0	128,0
e ø	18,0	18,0	18,0	23,0	23,0	23,0
f	56,6	64,0	71,0	76,0	76,0	85,0
Leiter mm ² min	1	1	1	2,5	2,5	2,5
Leiter mm ² max	2,5	2,5	2,5	6	6	6