

housing dimensions 460x276, with electrical interlocking PSK



Product description	
BALS-Prd.-Nr	1674
EAN	4024941016742

Logistics data	
Weight/pcs	0.0 kg / Piece
Packaging	Carton
Content amount	1 ST
EAN	4024941016742
Length	610 mm

Logistics data	
Width	410 mm
Height	430 mm
Weight	1.106 kg
Volume	98,400 ccm

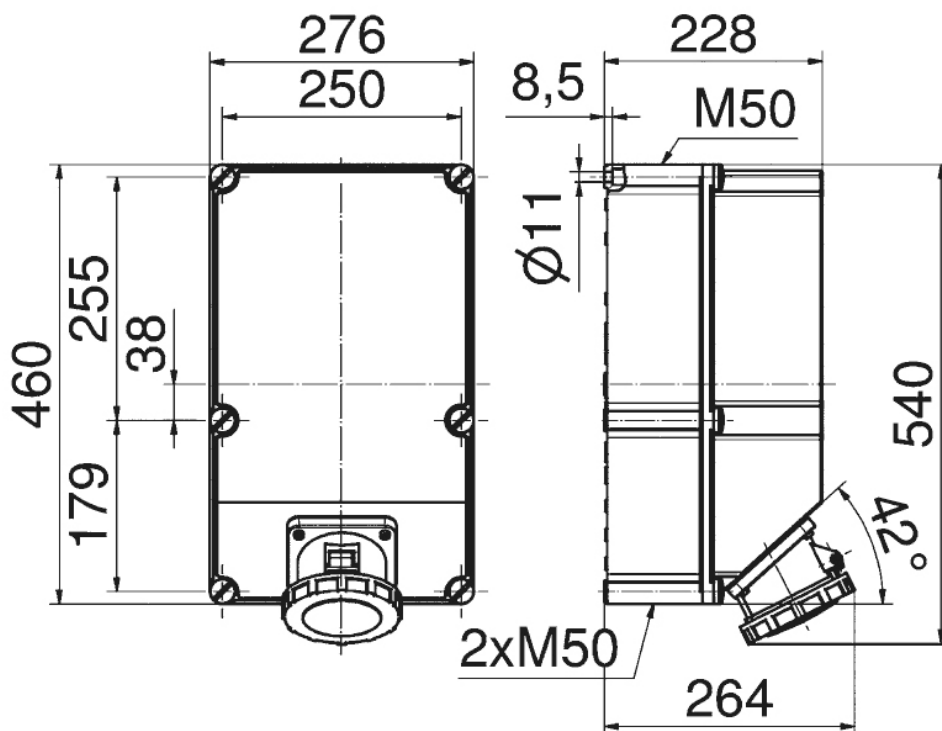

30 MB 104