

wall mounting socket outlet, switched, interlocked - housing dimensions 260x160



Product description	
BALS-Prd.-Nr	16606
EAN	4024941166065
product category	TE wall mounting socket outlet, switched, interlocked
current	63A
number of poles	3p
number of poles	2P+PE
position of earth contact	6 h
voltage	200 up to 250V

Product description	
frequency	50 and 60Hz
protection degree	IP67
colour code	blue RAL 5015
Colour of appliance	Hinged lid blue, Bayonet ring grey, Housing screws grey, Housing bottom grey, Housing top grey, Control knob grey
connection design	screw terminal as box terminal with Kontex-contact
maximum conductor size	25.0 qmm
cable entry	top entry M40, bottom entry M40/M32
Height	304mm
Width	160mm
Depth	195mm
dimension of enclosure	260x160 mm (HxW)
material of enclosure	Polycarbonate
contact	The contact carrier is made of high temperature resistant material, the contacts are brass nickel plated

Additional technical information	
	The cable entry is one at top and two at bottom open
	In 0-position lockable for 4 padlocks with bow diameter up to 7 mm

Logistics data	
Weight/pcs	2.135 kg / Piece

Logistics data	
Packaging	Carton
Content amount	1 ST
EAN	4024941166065
Length	325 mm
Width	217 mm
Height	210 mm
Weight	2.351 kg
Volume	13,588.4 ccm

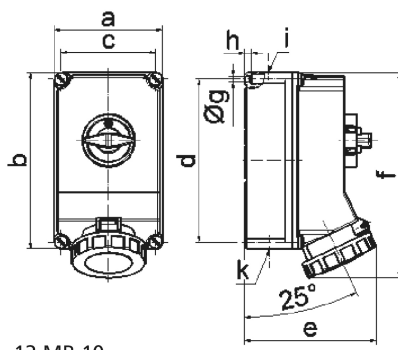

Ampere	63	63	63			
Polzahl	3	4	5			
a	160,0	160,0	160,0			
b	260,0	260,0	260,0			
c	140,0	140,0	140,0			
d	240,0	240,0	240,0			
e	195,0	195,0	195,0			
f	304,0	304,0	304,0			
g ø	8,1	8,1	8,1			
h	10,0	10,0	10,0			
i	M40	M40	M40			
k	M32/40	M32/40	M32/40			