

## wall mounting socket outlet, fused - housing dimension 225x118, with mounting rail



Product description	
BALS-Prd.-Nr	1583
EAN	4024941015837
product category	TE wall mounting socket outlet, fused
current	16A
number of poles	5p
number of poles	3p+N+PE
position of earth contact	6 h
voltage	200/346 up to 240/415V

Product description	
frequency	50 and 60Hz
protection degree	IP44
colour code	red RAL 3000
Colour of appliance	Operating window smoky topaz, Hinged lid red, Housing screws grey, Housing bottom grey, Housing top grey
connection design	screwless spring terminals as cage clamp with Kontext-contact
maximum conductor size	4,0 qmm
cable entry	top entry M25/M25 bottom entry M25
Height	243mm
Width	118mm
Depth	130mm
dimension of enclosure	225x118 mm (HxW)
material of enclosure	Polycarbonate
contact	The contact carrier is made of high temperature resistant material, the contacts are brass nickel plated

Additional technical information	
	The cable entry is one at top open, one at top is closed, and two at bottom are closed
	With mounting rail, Protective cover for fuses with stamping, With mounting rail for 5 modules, vertical

Logistics data	
Weight/pcs	0.84 kg / Piece
Packaging	Carton
Content amount	1 ST
EAN	4024941015837
Length	275 mm
Width	175 mm
Height	137 mm
Weight	0.965 kg
Volume	5,737.5 ccm

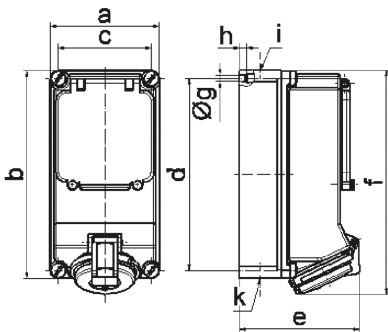

14 MB 13

Ampere Polzahl	16 4	16 5	32 3	32 4	32 5
a	118,0	118,0	118,0	118,0	118,0
b	225,0	225,0	225,0	225,0	225,0
c	101,0	101,0	101,0	101,0	101,0
d	208,0	208,0	208,0	208,0	208,0
e	123,0	130,0	134,0	134,0	141,0
f	242,0	242,0	250,0	250,0	250,0
g	6,5	6,5	6,5	6,5	6,5
h ø	8,0	8,0	8,0	8,0	8,0
i	2 x M25	2 x M25	2 x M25	2 x M25	2 x M25
k	2 x M25	2 x M25	2 x M25	2 x M25	2 x M25