

wall mounting socket outlet, fused - housing dimension 170x90, with C-type MCB



Product description	
BALS-Prd.-Nr	1535
EAN	4024941015356
product category	TE wall mounting socket outlet, fused
current	16A
number of poles	4p
number of poles	3P+PE
position of earth contact	9 h
voltage	200 up to 250V

Product description	
frequency	50 and 60Hz
protection degree	IP67
colour code	blue RAL 5015
Colour of appliance	Operating window smoky topaz, Hinged lid blue, Bayonet ring grey, Housing bottom grey, Housing top grey
connection design	screwless spring terminals as cage clamp with Kontext-contact
maximum conductor size	4,0 qmm
cable entry	top entry M20, bottom entry M25/20
Height	194mm
Width	90mm
Depth	115mm
dimension of enclosure	170x90 mm (HxW)
material of enclosure	Polycarbonate
contact	The contact carrier is made of high temperature resistant material, the contacts are brass nickel plated

Additional technical information	
	The cable entry is one at top open and two at bottom closed
	Lower part of housing rotatable by 180°
	With 3 pole C-type MCB

Logistics data	
Weight/pcs	0.0 kg / Piece
Packaging	Carton
Content amount	1 ST
EAN	4024941015356
Length	205 mm
Width	102 mm
Height	134 mm
Weight	0.06 kg
Volume	2,118.48 ccm

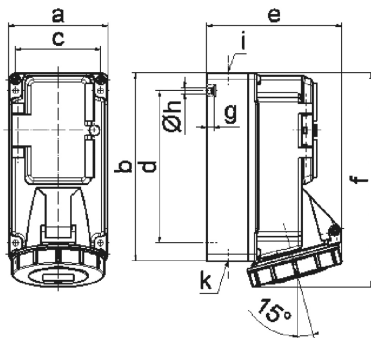

14 MB 6

Ampere	16	16	16			
Polzahl	3	4	5			
a	90,0	90,0	90,0			
b	170,0	170,0	170,0			
c	77,0	77,0	77,0			
d	137,5	137,5	137,5			
e	108,0	115,0	121,0			
f	191,5	191,5	191,5			
g	6,0	6,0	6,0			
h ø	5,5	5,5	5,5			
i	M20	M20	M20			
k	M20/25	M20/25	M20/25			