

for Event technology



Product description	
BALS-Prd.-Nr	130271
EAN	4024941938907
product group	Panel mounting socket outlet Quick-Connect, straight
current	16A
number of poles	5p
Arrangement of the phases	3p+N+PE
position of earth contact	6 h
voltage (V)	200/346 up to 240/415V
frequency	50 and 60Hz

Product description	
protection degree	IP44
colour code	red RAL 3000
Colour of appliance	Enclosure black, Hinged lid black
connection design	screwless sping/cage/kontex
maximum conductor size (LQ)	4,0 qmm
cable entry (KE)	null
Height	86mm
Width	75mm
Depth	93mm
Flange size vertical	75mm
Flange size horizontal	75mm
Drill hole distance vertical	60mm
Drill hole distance horizontal	60mm
material of enclosure	Polyamide
contact	The contact carrier is made of high temperature resistant material, the contacts are brass nickel plated

Logistics data	
Weight/pcs	0.146 kg / Piece
Packaging	Bag
Content amount	1 ST
EAN	4024941938907

Logistics data	
Length	93 mm
Width	75 mm
Height	86 mm
Weight	0.147 kg
Volume	599.85 ccm
Packaging	Carton
Content amount	10 ST
EAN	4024941840286
Length	275 mm
Width	175 mm
Height	137 mm
Weight	1.585 kg
Volume	5,737.5 ccm

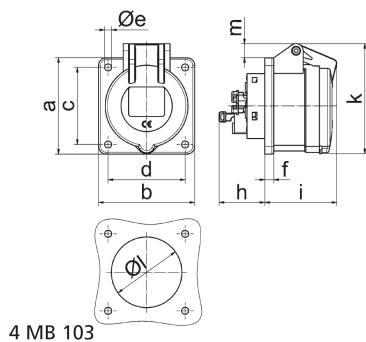

Ampere Polzahl	16 3	16 4	16 5	32 3	32 4	32 5
a	75,0	75,0	75,0	75,0	75,0	75,0
b	75,0	75,0	75,0	75,0	75,0	75,0
c	60,0	60,0	60,0	60,0	60,0	60,0
d	60,0	60,0	60,0	60,0	60,0	60,0
e ø	5,5	5,5	5,5	5,5	5,5	5,5
f	7,0	7,0	7,0	8,0	8,0	8,0
h	35,5	35,5	35,5	50,0	50,0	50,0
i	52,0	53,0	57,0	65,0	65,0	66,0
k	71,5	80,0	86,0	91,0	91,0	99,0
l ø	45,0	45,0	55,0	60,0	60,0	60,0
m	3,5	7,0	11,5	12,0	12,0	17,0
Leiter mm ² min	1,5	1,5	1,5	2,5	2,5	2,5
Leiter mm ² max	4	4	4	10	10	10