

panel mounting socket outlet, angled - flange 100x92,  
fixing centers 85x77



Product description	
BALS-Prd.-Nr	12782
EAN	4024941127820
product group	Panel mounting socket outlet Quick-Connect, angled
current	16A
number of poles	4p
Arrangement of the phases	3P+PE
position of earth contact	2 h
voltage (V)	> 50V

Product description	
frequency	over 300 up to 500Hz
protection degree	IP44
colour code	green RAL 6002
Colour of appliance	Hinged lid green, Enclosure grey
connection design	screwless sping/cage/kontex
maximum conductor size (LQ)	4,0 qmm
cable entry (KE)	null
Height	100mm
Width	92mm
Depth	93mm
Flange size vertical	100mm
Flange size horizontal	92mm
Drill hole distance vertical	85mm
Drill hole distance horizontal	77mm
material of enclosure	Polyamide
contact	The contact carrier is made of polyamide, The contacts are brass

Additional technical information	
	The inclination is 20°

Logistics data	
Weight/pcs	0.145 kg / Piece
Packaging	Carton
Content amount	10 ST
EAN	4024941829731
Length	245 mm
Width	177 mm
Height	185 mm
Weight	1.583 kg
Volume	7,140 ccm

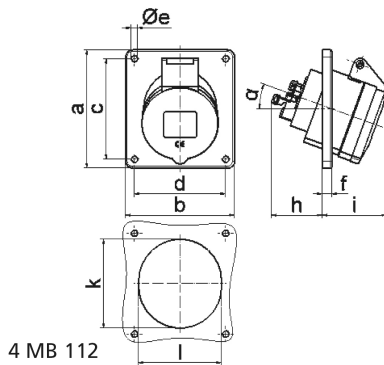

Ampere	16	16	16	32	32	32
Polzahl	3	4	5	3	4	5
a	74,0	100,0	100,0	100,0	100,0	100,0
b	62,0	92,0	92,0	92,0	92,0	92,0
c	60,0	85,0	85,0	85,0	85,0	85,0
d	52,0	77,0	77,0	77,0	77,0	77,0
e ø	5,5	5,5	5,5	5,5	5,5	5,5
f	8,0	8,0	8,0	8,0	8,0	8,0
h	46,0	46,0	46,0	55,0	55,0	55,0
i	48,0	50,0	55,0	68,0	68,0	60,0
k	57,0	65,0	70,0	75,0	75,0	78,0
l	52,0	65,0	70,0	75,0	75,0	78,0
α	20°	20°	20°	20°	20°	20°
Leiter mm <sup>2</sup> min	1,5	1,5	1,5	2,5	2,5	2,5
Leiter mm <sup>2</sup> max	4	4	4	10	10	10