

panel mounting socket outlet, angled - flange 74x62,
fixing centers 60x52



Product description	
BALS-Prd.-Nr	12776
EAN	4024941127769
product group	Panel mounting socket outlet Quick-Connect, angled
current	16A
number of poles	3p
Arrangement of the phases	2P+PE
position of earth contact	2 h
voltage (V)	> 50V

Product description	
frequency	over 300 up to 500Hz
protection degree	IP44
colour code	green RAL 6002
Colour of appliance	Hinged lid green, Enclosure grey
connection design	screwless sping/cage/kontex
maximum conductor size (LQ)	4,0 qmm
cable entry (KE)	null
Height	77mm
Width	62mm
Depth	89mm
Flange size vertical	74mm
Flange size horizontal	62mm
Drill hole distance vertical	60mm
Drill hole distance horizontal	52mm
material of enclosure	Polyamide
contact	The contact carrier is made of polyamide, The contacts are brass

Additional technical information	
	The inclination is 20°

Logistics data	
Weight/pcs	0.096 kg / Piece
Packaging	Carton
Content amount	10 ST
EAN	4024941829724
Length	207 mm
Width	162 mm
Height	142 mm
Weight	1.06 kg
Volume	3,750 ccm

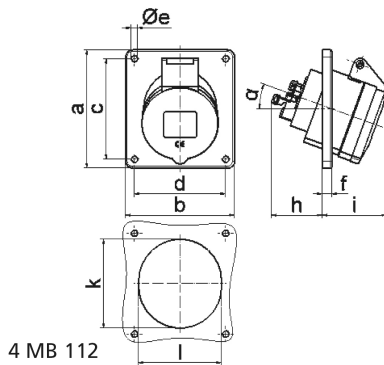

Ampere	16	16	16	32	32	32
Polzahl	3	4	5	3	4	5
a	74,0	100,0	100,0	100,0	100,0	100,0
b	62,0	92,0	92,0	92,0	92,0	92,0
c	60,0	85,0	85,0	85,0	85,0	85,0
d	52,0	77,0	77,0	77,0	77,0	77,0
e ø	5,5	5,5	5,5	5,5	5,5	5,5
f	8,0	8,0	8,0	8,0	8,0	8,0
h	46,0	46,0	46,0	55,0	55,0	55,0
i	48,0	50,0	55,0	68,0	68,0	60,0
k	57,0	65,0	70,0	75,0	75,0	78,0
l	52,0	65,0	70,0	75,0	75,0	78,0
α	20°	20°	20°	20°	20°	20°
Leiter mm ² min	1,5	1,5	1,5	2,5	2,5	2,5
Leiter mm ² max	4	4	4	10	10	10