

wall mounting socket outlet - housing dimensions 170x118



Product description	
BALS-Prd.-Nr	1159
EAN	4024941011594
product group	Wall mounting socket outlet
current	63A
number of poles	4p
Arrangement of the phases	3P+PE
position of earth contact	4 h
voltage (V)	100 up to 130V

Product description	
frequency	50 and 60Hz
protection degree	IP67
colour code	yellow RAL 1012
Colour of appliance	Hinged lid yellow, Bayonet ring grey, Housing bottom grey, Housing top grey
connection design	kontex contact
maximum conductor size (LQ)	25.0 qmm
cable entry (KE)	top entry M40, bottom entry M32
Height	228mm
Width	118mm
Depth	176mm
dimension of enclosure (GG)	170x118 mm (HxW)
material of enclosure	Polycarbonate
contact	The contact carrier is made of high temperature resistant material, the contacts are brass nickel plated

Additional technical information	
	The cable entry is one at top open and two at bottom closed
	Lower part of housing rotatable by 180°

Logistics data	
Weight/pcs	0.86 kg / Piece

Logistics data	
Packaging	Carton
Content amount	5 ST
EAN	4024941827553
Length	345 mm
Width	345 mm
Height	217 mm
Weight	4.635 kg
Volume	24,276 ccm

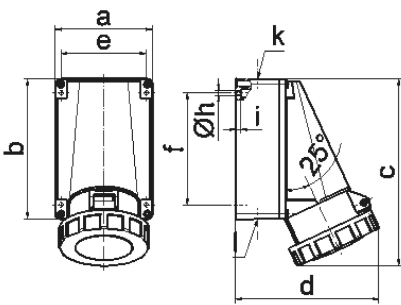

1 MB 3

Ampere Polzahl	63 3	63 4	63 5				
a	118,0	118,0	118,0				
b	170,0	170,0	170,0				
c	228,0	228,0	228,0				
d	176,0	176,0	176,0				
e	104,0	104,0	104,0				
f	136,0	136,0	136,0				
h ø	6,1	6,1	6,1				
i	6,0	6,0	6,0				
k	M40	M40	M40				
l	M32/32	M32/32	M32/32				
Leiter mm ² min	6	6	6				
Leiter mm ² max	25	25	25				