

wall mounting socket outlet, chemically resistant - housing dimensions 170x90



Product description	
BALS-Prd.-Nr	11453
EAN	4024941114530
product group	TE wall mounting socket outlet Quick-Connect
current	16A
number of poles	4p
Arrangement of the phases	3P+PE
position of earth contact	6 h
voltage (V)	380 up to 415V

Product description	
frequency	50 and 60Hz
protection degree	IP67
colour code	red RAL 3000
Colour of appliance	Bayonet ring lightbeige, Housing top lightbeige, Hinged lid red, Housing bottom lightbeige
connection design	screwless sping/cage/kontex
maximum conductor size (LQ)	4,0 qmm
cable entry (KE)	top entry M20, bottom entry M25/20
Height	194mm
Width	90mm
Depth	115mm
dimension of enclosure (GG)	170x90 mm (HxW)
material of enclosure	Polycarbonate - Polyethylene terephthalate light beige
contact	The contact carrier is made of high temperature resistant material, the contacts are brass nickel plated

Additional technical information	
	The cable entry is one at top open and two at bottom closed
	Lower part of housing rotatable by 180°

Logistics data	
Weight/pcs	0.44 kg / Piece

Logistics data	
Packaging	Carton
Content amount	1 ST
EAN	4024941114530
Length	205 mm
Width	102 mm
Height	134 mm
Weight	0.5 kg
Volume	2,118.48 ccm

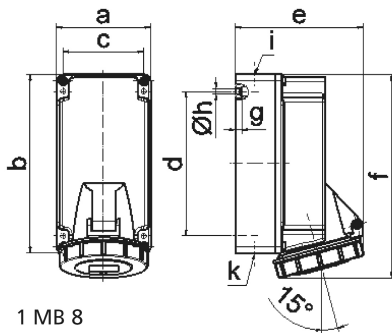

Ampere	16	16	16			
Polzahl	3	4	5			
a	90,0	90,0	90,0			
b	170,0	170,0	170,0			
c	77,0	77,0	77,0			
d	137,5	137,5	137,5			
e	108,0	115,0	122,0			
f	191,5	191,5	195,0			
g	6,5	6,5	6,5			
h \varnothing	5,5	5,5	5,5			
i	M20	M20	M20			
k	M20/25	M20/25	M20/25			
Leiter mm ² min	1,5	1,5	1,5			
Leiter mm ² max	4	4	4			